

**GENERAL NOTES:**

- Do not scale Drawings. If drawings are in question or discrepancy, the builder shall be responsible for obtaining clarification from the building designer and or building surveyor before continuing with construction.
- All dimensions relating to existing conditions shall be field verified.
- Where otherwise specified all products shall be installed according to Radial Timbers specifications. This applies not withstanding any relevant Building Act, Regulation, Building Code of Australia, Local Government Regulation/Requirement and Australian Standard.
- Radial Timbers recommends the following gap spacing for V/Join Shiplap:
  - 45mm & 70mm - 3mm Gap spacing
  - 90mm & 110mm - 5mm Gap spacing
- All external timbers to be treated against weather exposure to current AS 1604 specifications or no less than durability Class 1 In-Ground/Class 2 Above Ground as per AS 5604 Timber Natural Durability Ratings.
- All external steel & fixings to be a minimum of Hot Dip Galvanized or equivalent corrosion protection to AS 2311 & 2312 unless within 1Km from a salt water environment then Marine grade Stainless steel is to be used, except where noted otherwise by the NCC.
- All Residential timber framing, bracing & tie downs are to be in accordance to AS 1684 (Commercial construction specifications to be provided by Engineer).
- Compliance with the relevant National Construction Code Of Australia (NCC) Volume 1 & or Volume 2 is mandatory (Not limited to) & the GUIDE TO STANDARDS & TOLERANCES.
- Compliance with the (NCC) Volume 1:
  - 3.5.3.2 Timber Cladding & 3.5.3.6 Flashings to wall openings**
  - Openings in *external wall* cladding exposed to the weather must be flashed as follows:
    - All openings must be adequately flashed using materials that comply with AS/NZS 2904.
    - Flashings must be securely fixed at least 25 mm under the cladding
- Compliance with the following Australian Standards is mandatory (Not limited to):
  - AS 1684 TIMBER FRAMED CONSTRUCTION
  - AS 5604 NATURAL TIMBER DURABILITY
  - AS 3959 CONSTRUCTION IN BUSHFIRE AREAS
  - AS 2796.1 TIMBER HARDWOOD - SAWN & MILLED PRODUCTS (PRODUCT SPECIFICATION)
  - AS 2047 WINDOWS IN BUILDINGS
  - AS 2870 RESIDENTIAL SLABS & FOOTINGS
  - AS 1250 THE USE OF STEEL IN STRUCTURES
  - AS 4100 STEEL STRUCTURES
  - AS 2311 PAINTING OF BUILDINGS
  - AS 3600 TERMITE MANAGEMENT
  - AS 1170 STRUCTURAL DESIGN ACTIONS
  - AS 1428 DESIGN FOR ACCESS AND MOBILITY
  - AS 1675 FIXED PLATFORMS, WALKWAYS, STAIRWAYS AND LADDERS - DESIGN, CONSTRUCTION AND INSTALLATION
- All underground services (Sewer, Drainage, Gas, Electric, telecommunications, etc;) to be determined on site & from relevant authority records, prior to commencement of any construction.

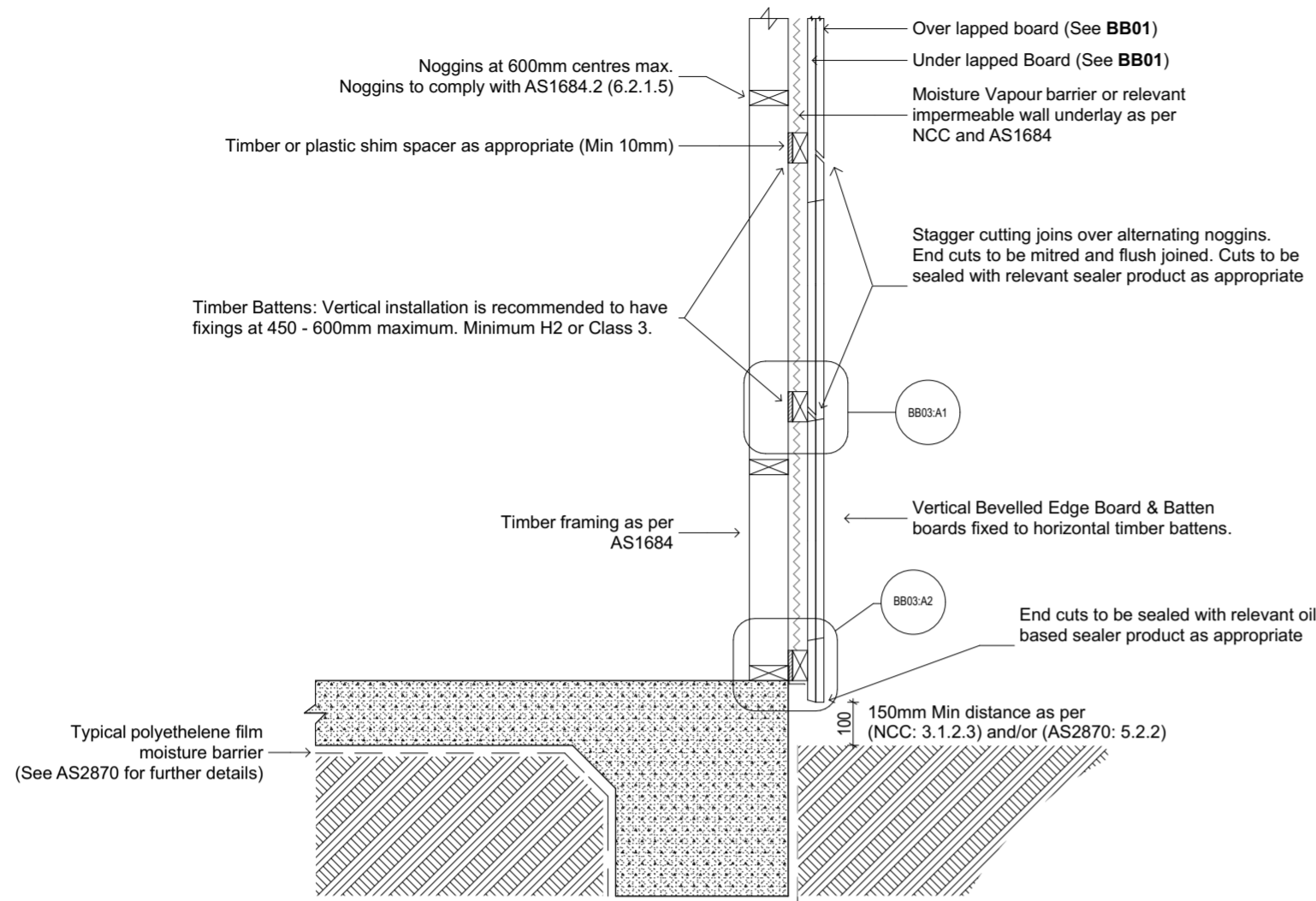

1.0 BB03:A - BE Board & Batten Batten Fixing SOG 1:15

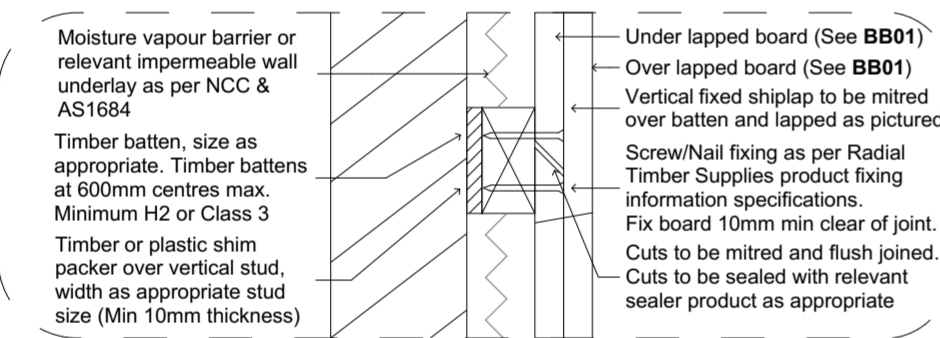

1.1/2.1 BB03:A1 & BB03:B1 - Vertical B&B Mitre Join 1:5

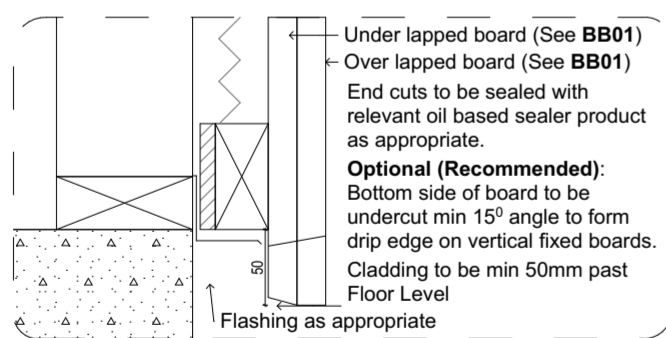

1.2 BB03:A2 - Vertical Board & Batten End Flashing 1:5

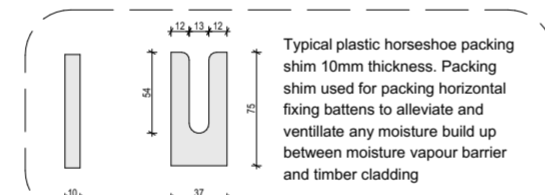

3.0 Typical Plastic Packer 1:5

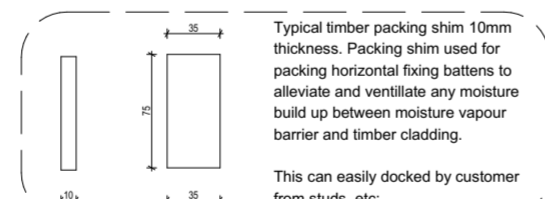

4.0 Typical Timber Packer 1:5

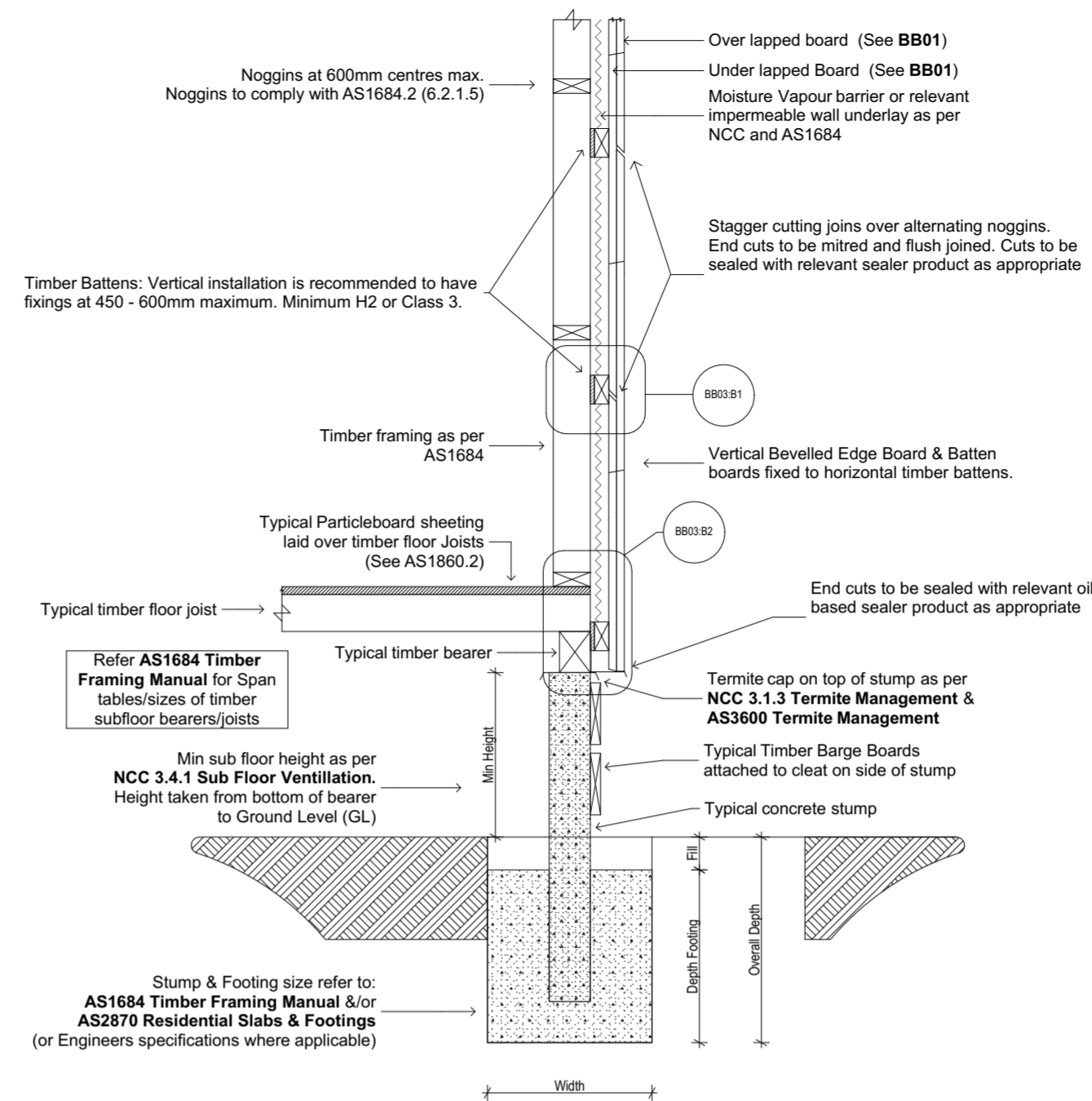

2.0 BB03:B - BE Board & Batten Batten Fixing Timber Sub-Floor 1:15

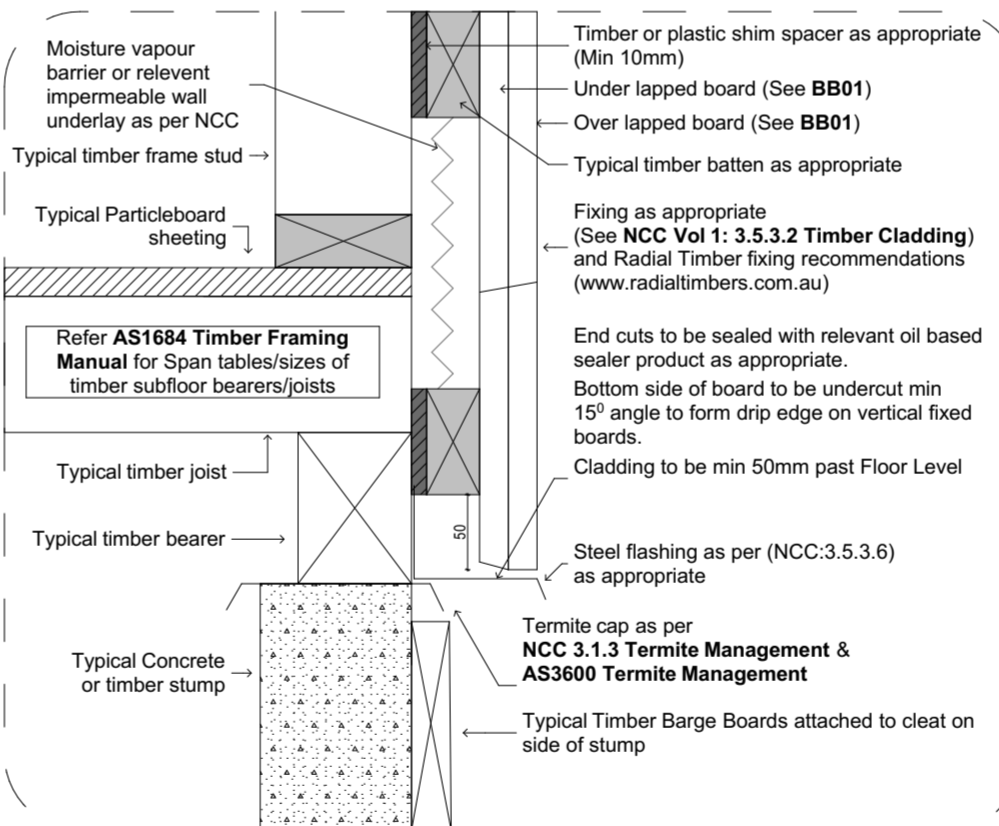

2.2 BB03:B2 - Vertical Board & Batten End Flashing 1:5

**IMPORTANT:**  
Refer to Radial Timber Product specifications for further fixing information:  
[www.radialtimbers.com.au](http://www.radialtimbers.com.au)

**NOTE:**  
Radial Timber Product specifications noted here-in are manufacturers information for guidance purposes only. Adherence with applicable Building Acts, Building Regulations, National Construction Codes, Local Government Regulations/Planning, Australian Standards must take precedence.

**NOTE:**  
Termite Treatment in accordance with AS3600 required.  
Installer to comply with AS3959 - Construction In Bushfire areas.

**NOTES:**  
THE BUILDER SHALL CHECK AND VERIFY ALL DIMENSIONS AND NOTIFY ALL ERRORS AND OMISSIONS TO THE DESIGNER. DRAWINGS ARE NOT TO BE USED FOR CONSTRUCTION UNTIL ISSUED BY THE DESIGNER FOR CONSTRUCTION. DO NOT SCALE DRAWINGS. USE FIGURED DIMENSIONS ONLY.  
**FIXING DETAILS:**  
REFER TO RADIAL TIMBERS RECOMMENDED FIXINGS ([www.radialtimbers.com.au](http://www.radialtimbers.com.au))

RADIAL TIMBER SALES  
12 PARK DRIVE,  
DANDENONG SOUTH 3175  
PH: (03) 9768 2100  
FAX: (03) 9768 2177  
EMAIL: [sales@radialtimbers.com.au](mailto:sales@radialtimbers.com.au)  
WEB: [www.radialtimbers.com.au](http://www.radialtimbers.com.au)



DRAWING NAME:  
Radial Board & Batten Wall (Batten) Fixing Details

SCALE: A2 - Not To Scale  
DATE: 18-Feb-17  
DWG NO: BB03  
REVISION: 04